

hidrotren

NETWELL
S.P.A. 1978

Sistemas y Tecnología del agua / Water System Technology



FAMILIA 13 FAMILY

V. DE RETENCIÓN SYSTEM® SYSTEM® CHECK VALVES

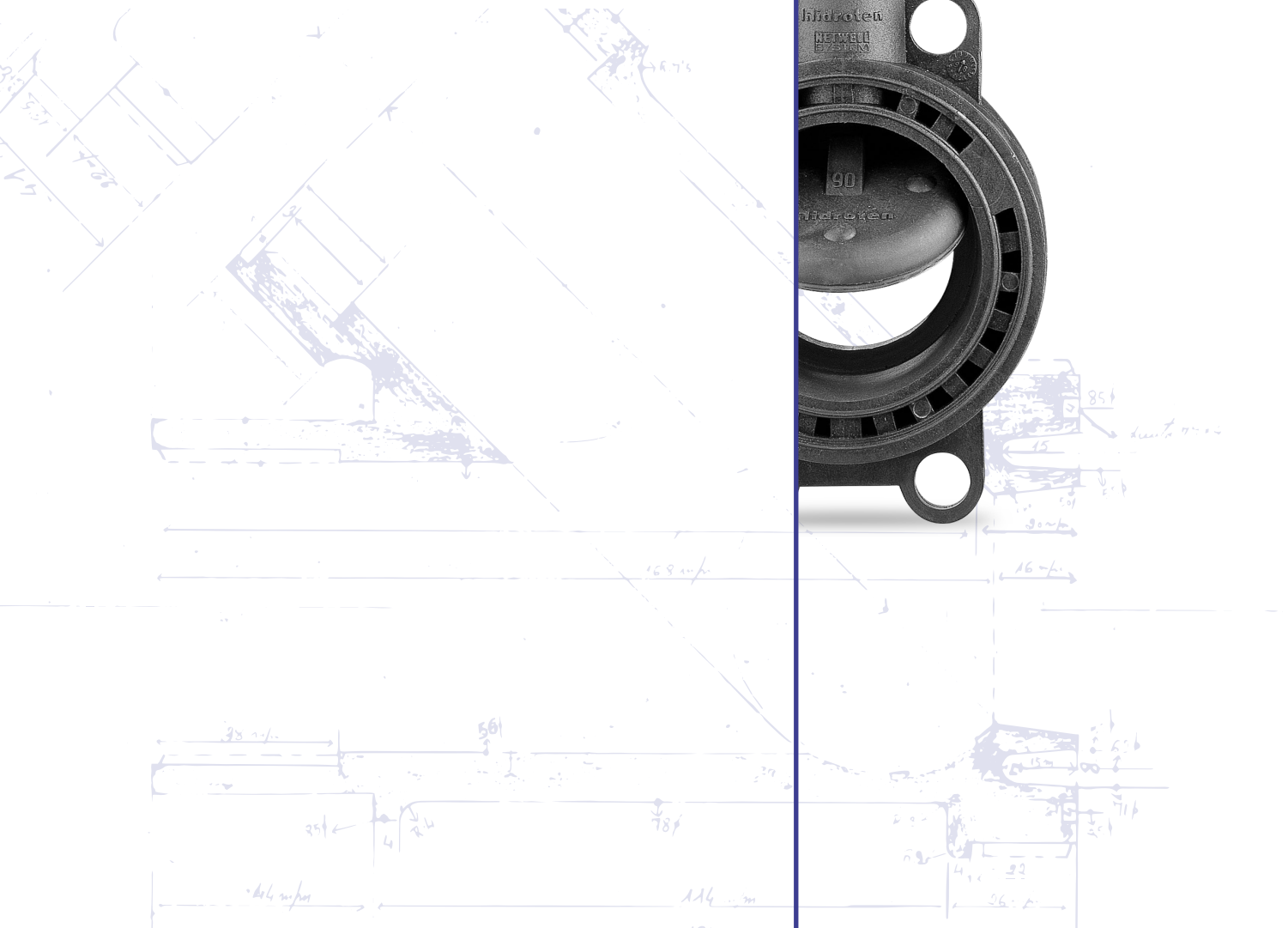



Válvula de retención System PPFV

La válvula de retención System, ofrece un magnífico comportamiento en las instalaciones, aportando gran resistencia a los fenómenos de golpe de ariete así como una mínima pérdida de carga con una estanqueidad garantizada con una presión de 0,1 bar.

The System check valve offers a great performance in the installations, providing a great resistance to the water hammering as well as a minimum loss of charge with guaranteed water tightness at a 0,1 bar pressure.



Conexión brida multinorma

La válvula de retención System está dotada de alojamientos para los tornillos que la hacen compatible con las diferentes normas de bridas existentes en el mundo, como son la DIN 8063, ANSI 16.5, BS10 tablas D/E, UNE-EN 1452.

The System check valve has housing for the screws which make it compatible to the different existing flange norms all around the world, such as the DIN 8063, ANSI 16.5, BS10 tables D/E, UNE-EN 1452.



Dos opciones de cierre

La válvula de retención System ofrece dos sistemas de cierre: clapeta libre y auto-cierre visor. El sistema de clapeta libre, minimiza la pérdida de carga. El autocierre-visor, que permite visualizar si la válvula está funcionando correctamente o algún elemento está impidiendo su cierre, ha evolucionado convirtiéndose en un sistema libre de mantenimiento al eliminar el vástago móvil externo.

The System check valve has two closing systems: free flap and self-closing fluid display. The free flap system, minimizes pressure losses. The self-closing viewer, allows to visualize if the valve is working correctly or if some element is preventing its closing, has evolved to a maintenance-free system by eliminating the external moving piston.



CERTIFICACIONES / CERTIFICATIONS

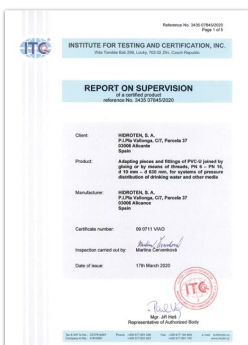

En tuberías según norma UNE-EN 1452 (PVC-U) y UNE-EN 12201 (PE).

Inside the pipes according to the standard UNE-EN 1452 (PVC-U) and UNE-EN 12201 (PE).

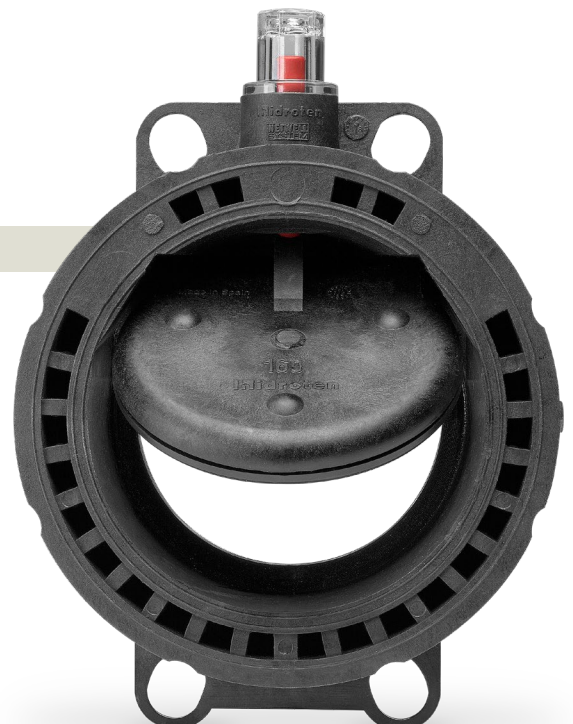

SECTOR	Gestión y tratamientos de aguas, piscina, riego e industria / <i>Water treatments, swimming pool, irrigation and industry</i>
MATERIAL	PPFV-PPR / GFPP-PPR
JUNTAS / SEAL	EPDM / EPDM
MUELLE / SPRING	Inox 304
MONTAJE / ASSEMBLY	Se pueden usar en vertical u horizontal / <i>May be used either vertically and horizontal</i>
TIPO / TYPE	Clapeta "libre" / <i>Free flap</i> Auto-cierre visor / <i>Auto-lock with position indicator</i>
PN	PN 16 desde Ø63 a 140 / <i>PN 16 from Ø63 to 140</i> PN 10 desde Ø160 a 315 / <i>PN 10 from Ø160 to 315</i> PN 6 Ø400 / <i>PN 6 Ø400</i>
MEDIDAS / MEASURES	Desde Ø63 a 400 / <i>From Ø63 to 400</i>

DESPIECE / QUARTERING

1. Tapón transparente PC
2. Junta de cierre NBR
3. Muelle autocierre Inox 304
4. Vástago indicador PP
5. Cuerpo central PPFV/PPR Ø400
6. Eje clapeta Inox A-2
7. Tornillo sujeción Inox A-4
8. Clapeta PVC / PPR Ø400
9. Junta clapeta EPDM
10. Pasador tornillería

1. Transparent polycarbonate cap
2. NBR Closing seal
3. Autoclosing spring stainless steel 304
4. PP Fastening piston rod rib
5. GFPP/PPR in Ø400, main body
6. Check axis stainless steel A-2
7. Fastening screw stainless steel A-4
8. U-PVC check lid/ PPR in Ø400
9. EPDM Check seal
10. Fastening bolt

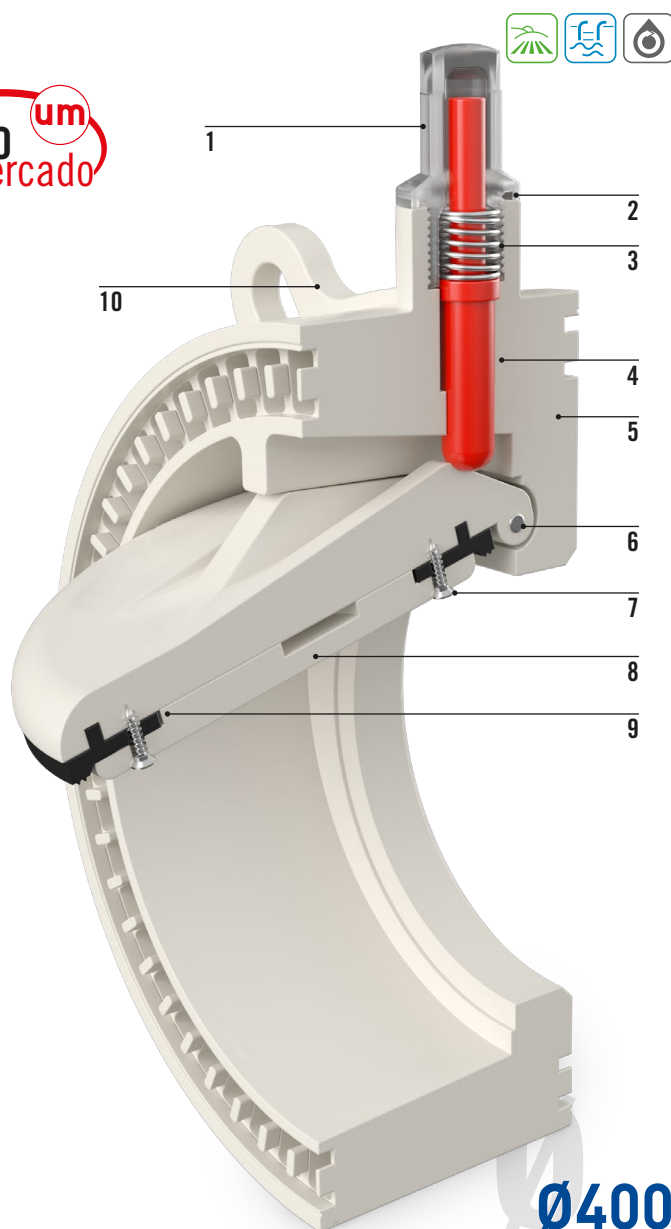
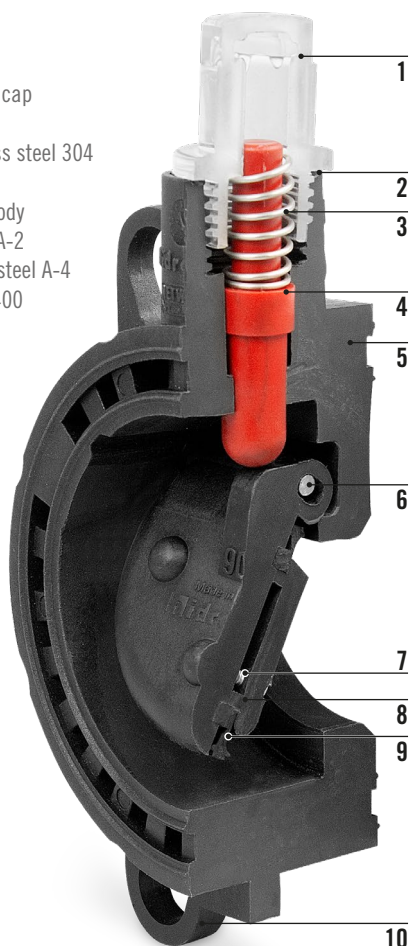

Ø400

CURVAS PÉRDIDAS DE CARGA / LOAD LOSS CURVES

Válvulas / Valves DN 65

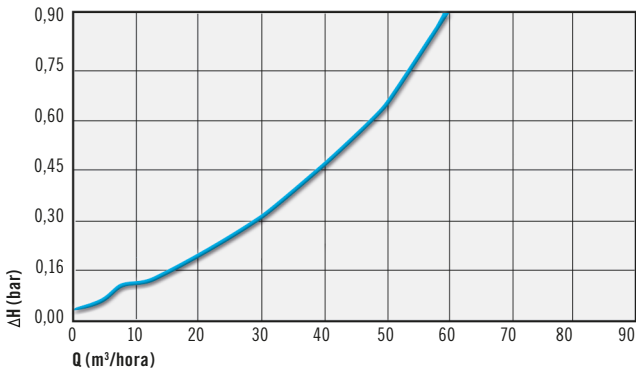

Válvulas / Valves DN 80

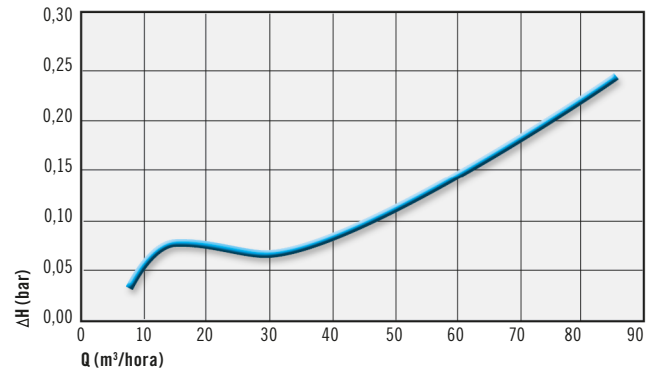

Válvulas / Valves DN 100

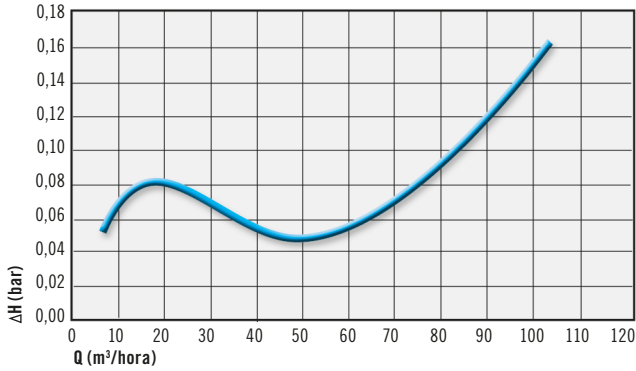

Válvulas / Valves DN 110

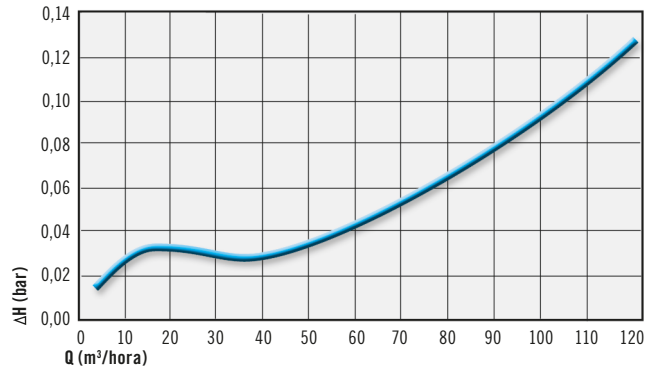

Válvulas / Valves DN 125

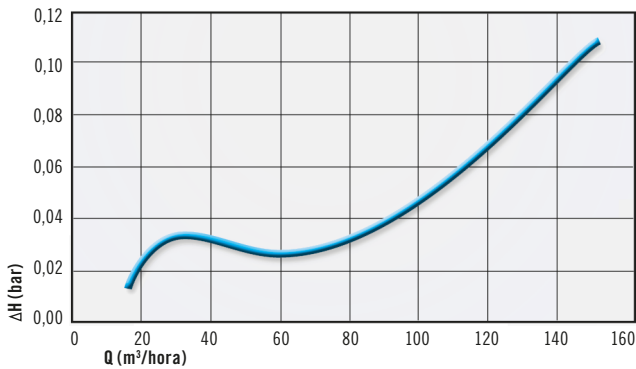

Válvulas / Valves DN 150

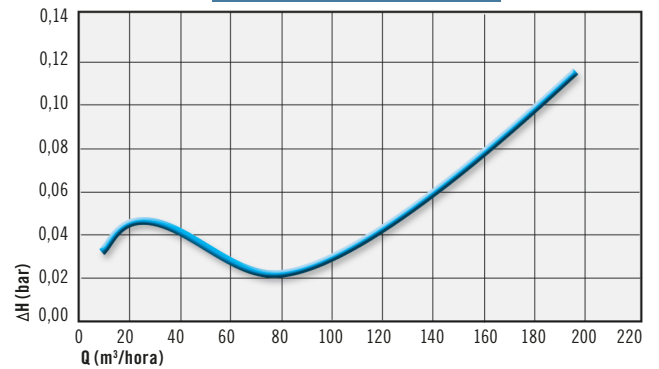

Válvulas / Valves DN 200

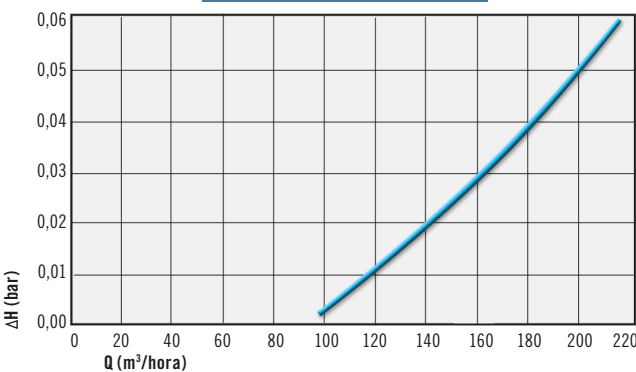

Válvulas / Valves DN 250

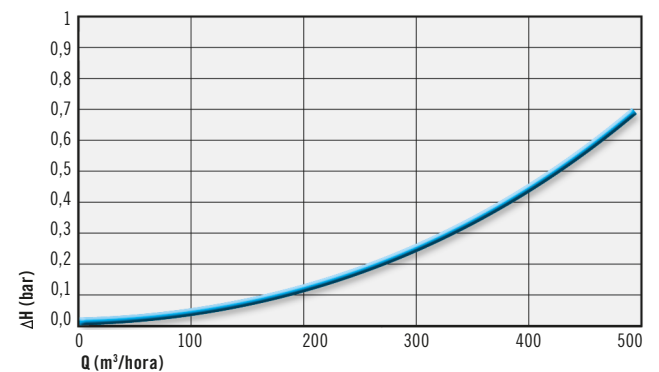

CURVAS PÉRDIDAS DE CARGA / LOAD LOSS CURVES

Válvulas / Valves DN 300

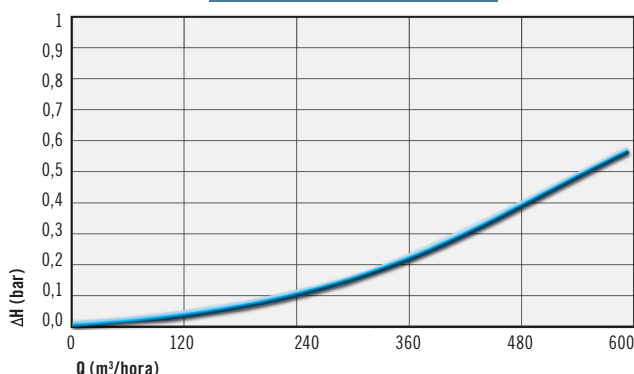

Válvulas / Valves DN 400

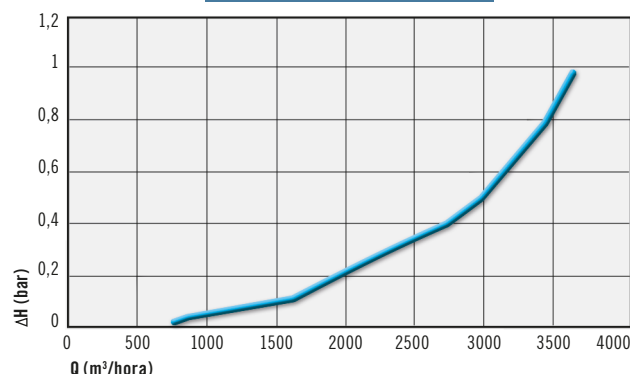

CARACTERÍSTICAS VÁLVULAS DE RETENCIÓN / SYSTEM® CHECK VALVE CHARACTERISTICS

Las válvulas de retención o antirretorno son válvulas cuya finalidad es impedir inversiones en el sentido de la circulación. Su funcionamiento es automático, controlado por el sentido de circulación del fluido y las presiones del sistema.

Las principales **funciones** de este tipo de válvulas son tres:

- **Vaciado de instalaciones**, sobre todo en la zona de impulsión para que las bombas queden cebadas adecuadamente.
- **Contraflujo** tras operaciones tales como filtraciones e inyecciones de productos químicos, esto permite tener controladas las modificaciones que se realizan sobre el fluido.
- **Evita el golpe de ariete** en las instalaciones, al encargarse las válvulas de retención de detener las ondas de presión y evitar que se propaguen.

Existen diferentes opciones de válvulas por un lado están las de **clapeta o columpio**. En este caso el mecanismo que debe de garantizar el óptimo funcionamiento de la válvula es un disco sujeto por uno de sus extremos mediante una bisagra al cuerpo de la válvula, abriéndose completamente en el sentido normal de trabajo y cerrándose al producirse la inversión. Este diseño es especialmente recomendable cuando se necesita mínima resistencia a la circulación y es el preferente en diámetros a partir de 90 mm.

The purpose of check valves and check valves with spring is to prevent reversals of the flow. They work automatically and are controlled by the fluid flow and the system pressures.

The main **functions** of these valves are three:

- **Dumping of installations**, above all in the jet area to prime the pumps properly.
- **Counterflow** after operations such as leaks or injections of chemicals, which allows us to control the modifications carried out on the fluid.
- **Avoiding the water hammering** in the installations, as the check valves are in charge of stopping the pressure waves and preventing their spread.

There are different options of valves. On the one hand, we have the **flat or swing valves**. In this case, the mechanism which ensures the optimal operation of the valve is a disk fastened by one of its edges through a hinge to the valve, opening completely in the normal direction of work and closing at a reversal. This design is especially advisable when the minimum resistance to flow is needed and when it is preferable in diameters larger than 90 mm.

APRIETE BRIDAS / TIGHTENS FLANGES

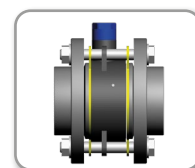
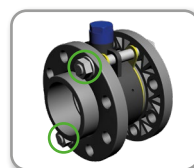
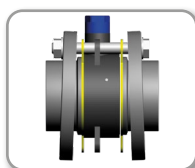
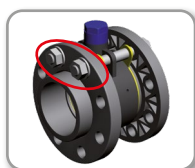

SECUENCIA INCORRECTA DE APRIETE/INCORRECT SEQUENCE OF TIGHTENS



SECUENCIA CORRECTA DE APRIETE/CORRECT SEQUENCE OF TIGHTENS

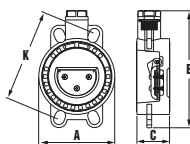

285

Retención System®
System® Check valve
Vanne anti-retour System®

CÓDIGO / CODE	Ø TUBO / PIPE	DN	PESO / WT (g.)	A	B	C	K
13000	63	50	430	136	172	54	125-145
13001	75	65	430	136	172	54	125-145
13002	90	80	620	130	201	58	146-160
13003	110	100	753	151	220	59	178-190
13004	125	110	1.042	170	236	67	190
13005	140	125	1.394	190	255	73	210-216
13006	160	150	2.000	217	275	80	235-241
13007	200/225	200	2.890	250	321	95	292-298
13008	250	250	6.540	322	385	128	350-362
13009	315	300	10.300	370	485	131	400-425
13031	400	400	13.645	478	630	180	515-550

K= distancia entre tornillos (mm)/Distance between bolts (mm)

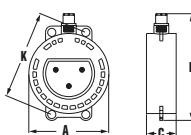

286

Retención System® auto/cierre visor
Check valve, auto lock and indicator
Vanne à mécanisme d'autofermeture et indicateur

CÓDIGO / CODE	Ø TUBO / PIPE	DN	PESO / WT (g.)	A	B	C	K
13020	63	50	465	136	202	54	125-145
13021	75	65	465	136	202	54	125-145
13022	90v	80	675	130	236	58	146-160
13023	110	100	808	151	257	59	178-190
13024	125	110	1.103	170	275	67	190
13025	140	125	1.455	190	292	73	210-216
13026	160	150	2.062	217	312	80	235-241
13027	200/225	200	2.950	250	344	95	292-298
13028	250	250	6.850	322	385	128	350-362
13029	315	300	10.520	370	495	131	400-425
13030	400	400	13.675	478	630	180	515-550

K= distancia entre tornillos (mm)/Distance between bolts (mm)

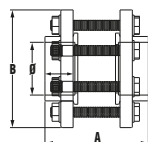

288

Enlace brida cónico
Conical flange set
Union bride conique

CÓDIGO / CODE	Ø TUBO / PIPE	DN	PESO / WT (g.)	A	B	C	Agujeros
10310	63	65	3.550	143	165	38	18x4
10304	75	65	3.650	162	185	44	18x4
10305	90	80	4.256	196	200	51	18x8
10306	110	100	5.002	205	220	60	18x8
10307	125	110	5.533	231	230	69	18x8
10308	140	125	6.512	257	250	76	18x8
10309	160	150	9.804	280	285	86	22x8
10325	200-PN 10	200	13.382	327	340	106	22x8
10326	225	200	12.172	354	340	127	22x8
10317	250	250	19.674	398	399	131	22x12
10318	315	300	25.200	490	450	164	22x12
10272	400	400	51.100	438	580	207	26x16

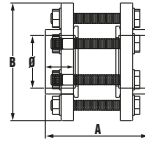

Enlace brida Imperial
Imperial flange set
Union bride Imperial

289

CÓDIGO / CODE	Ø TUBO / PIPE	DN	PESO / WT (g.)	A	B	C	Agujeros
10468	2"	65	3.550	143	165	38	18x4
10304	2 1/2"	65	3.650	162	185	44	18x4
10470	3"	80	4.035	195	200	51	18x8
10471	4"	100	4.930	206	220	60	18x8
10472	5"	125	6.424	246	250	69	18x8
10473	6"	150	9.225	275	285	86	22x8
10474	8"	200	12.410	351	340	106	22x8

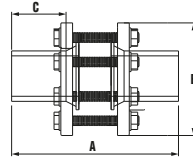

Enlace brida plano PE
Plain flange set for PE pipes
Union bride plate pour tuyaux PE

602

CÓDIGO / CODE	Ø TUBO / PIPE	DN	PESO / WT (g.)	A	B	C	Agujeros
10381	90	80	7.970	277	200	100	18x8
10382	110	100	9.808	284	220	102	18x8
10383	125	110	10.320	352	230	135	18x8
10384	140	125	13.525	335	250	125	18x8
10385	160	150	17.750	333	285	122	22x8
10386	200	200	24.566	355	340	132	22x8
10387	225	200	27.235	368	340	136	22x8
10388	250	250	29.446	473	399	180	22x12
10389	315	300	31.400	581	450	210	22x12

HIDROTEN, S.A.

Polig. I. Plá Vallonga, c/ Agua, 28
03006 ALICANTE (España)
Telf. 965 11 42 82
Fax: 965 11 48 62

I INTERNACIONALES I

Telf. +34 965 11 42 82
Fax: +34 965 11 48 62
Telf. Información Técnica:
+34 966 105 888

www.hidroten.es

I E-mails I

comercial@hidroten.es
export@hidroten.es
administracion@hidroten.es
tecnico@hidroten.es
publicidad@hidroten.es
prescripcion@hidroten.es



¡Síguenos en redes sociales!

